

POWERFAB MULTI TRAK

86

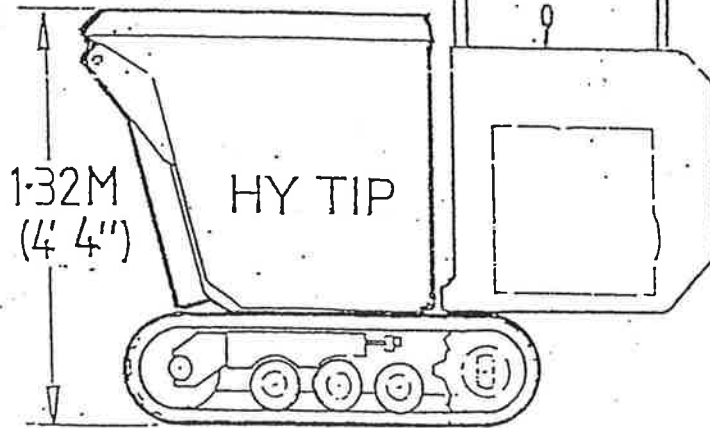
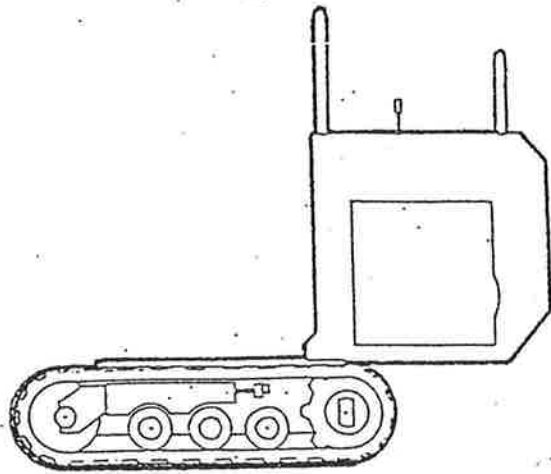
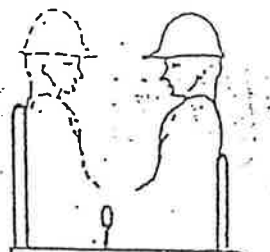

MULTI TRAK TOOL CARRIER
price

HY TIP DUMPER
price

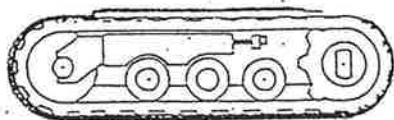

30" TO 40" VARIABLE
0.762m - 1.016m

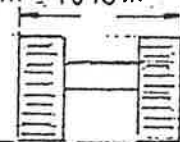

UNDERCARRIAGE

8" (200) WIDE
TRACK

Price

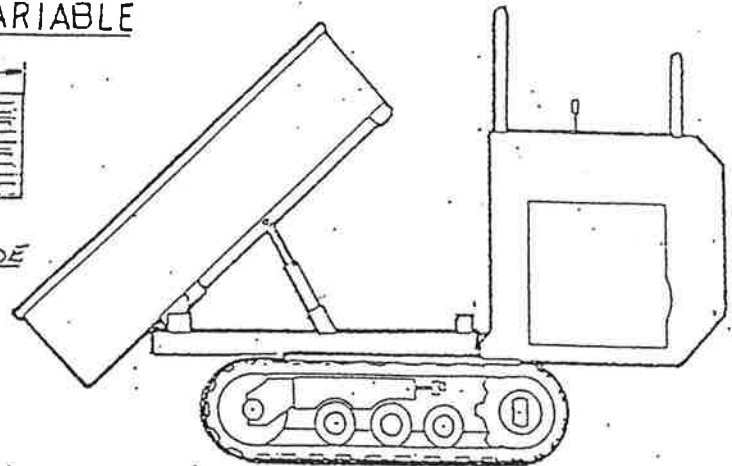

ONE WAY OR THREE WAY TIP
price one way tip
price three way tip

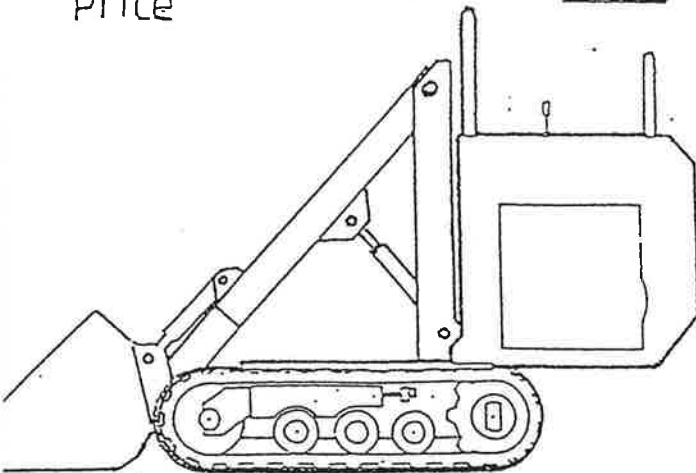

TRACK LOADER
price

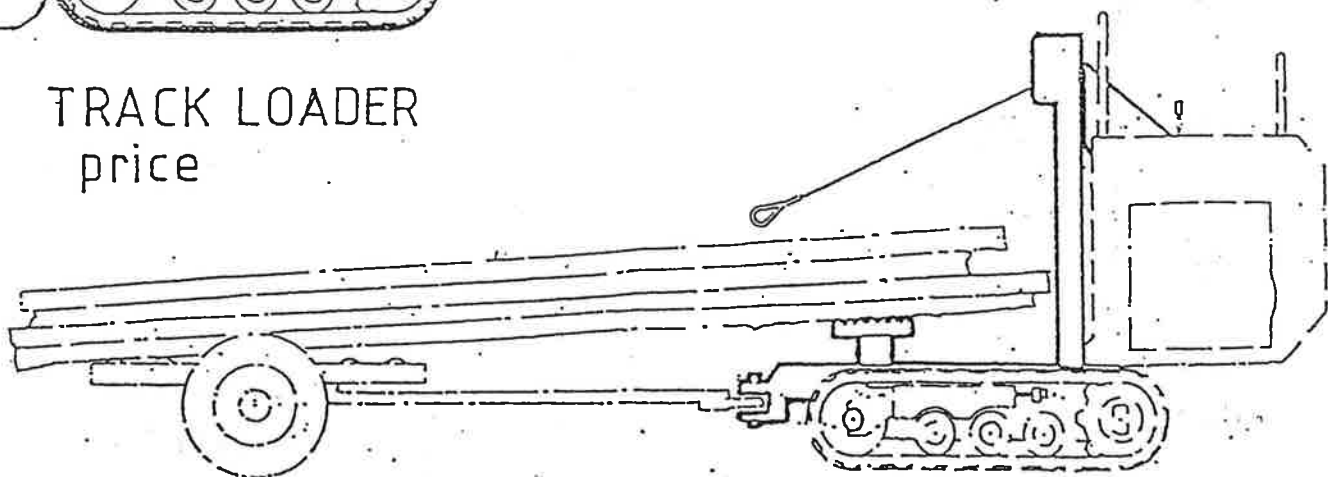

LOG HANDLING CARRIER AND HYDRAULIC WINCH
PRICE TO BE ADVISED

POWERFAB

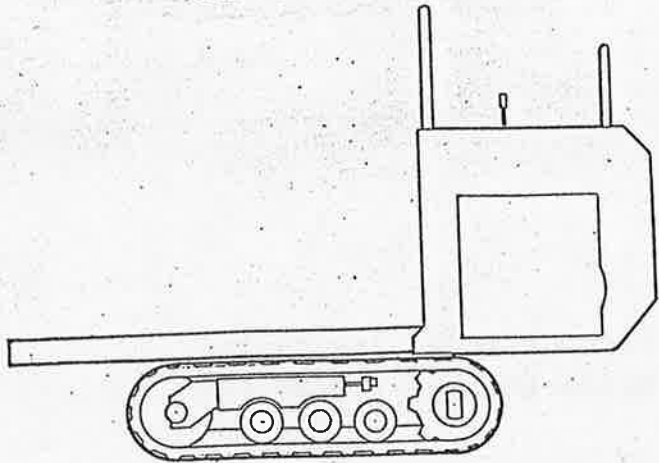

HYDRAULIC CARRIER FOR MOUNTING CUSTOMERS SPECIALIZED EQUIPMENT

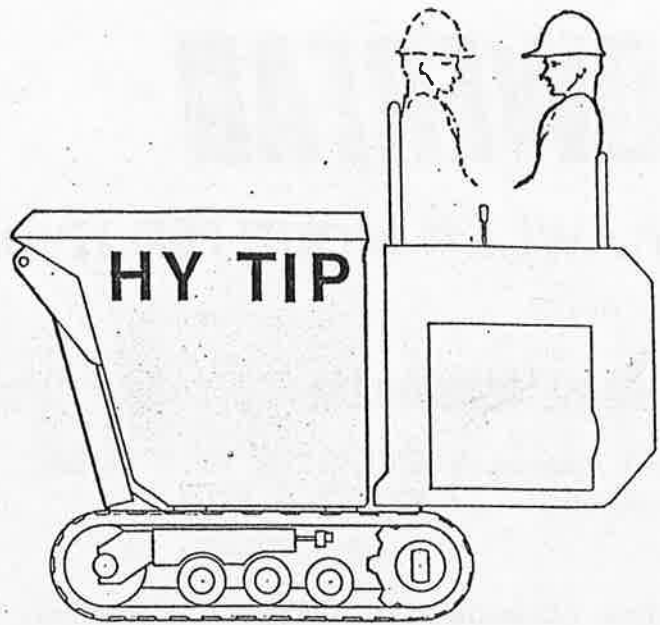

DUMPER

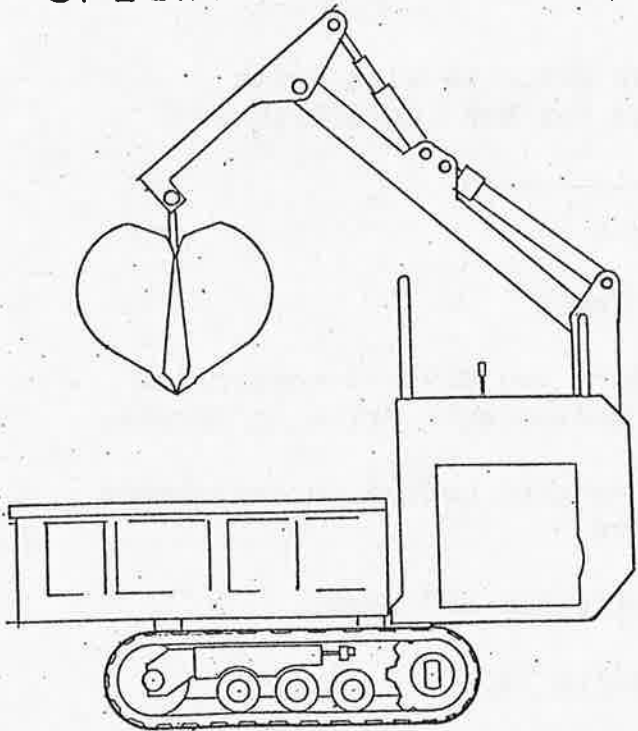

CRANE OR GRAB LOADER

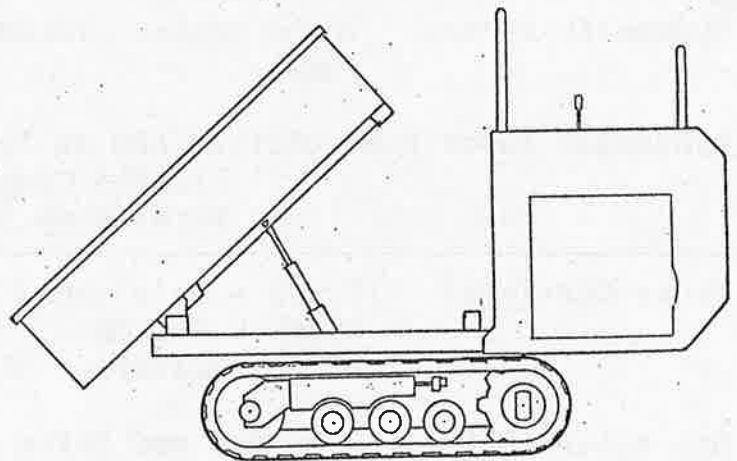

REAR OR THREE WAY TIP

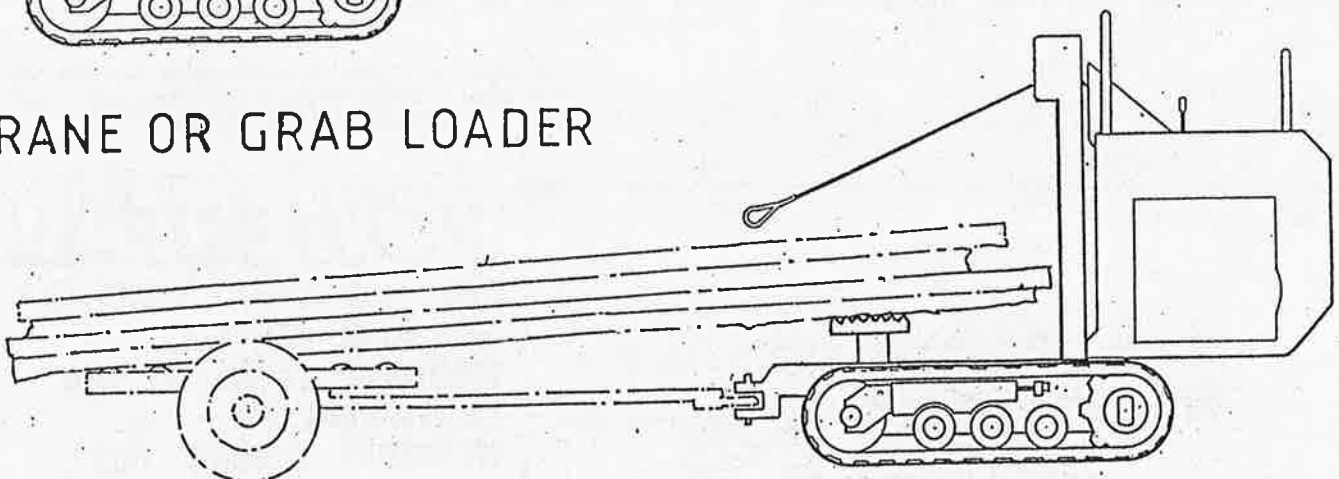

LOG HANDLING CARRIER AND HYDRAULIC WINCH

CRAWLER MOUNTED HYDRAULIC CARRIER

TECHNICAL INFORMATION

Rated capacity 650 Kilos to 1 Tonne.
Max Speed: 3.7 MPH (6.5 KPH).

Engine (Standard): Briggs & Stratton 15HP Twin Cylinder Air-Cooled Overhead Valve Petrol Engine (Briggs & Stratton Vanguard).

Engine (Optional): Mitsubishi 2 Cylinder Water Cooled Engine Electric Start Diesel 11.2 KW at 3600 RPM.

Hydraulic System: Turbo Cooled Hydraulic System Tandem Hydraulic Pump.

Hydraulic Power Take Off: 26 LPM at 186 Bar Complete with Quick Release Couplings for Hand Held Breaker Water Pump etc.

Under Carriage: Track - Reinforced Rubber
Width - 200 MM
No. of Rollers - 3 Per Track

Operation (Drive): Steering and Drive Forward and Reverse controlled by two Levers Indirect Hydrostatic Drive to Tracks.

Hydraulic Carrier: Supplied for attaching special bodies on attachment to customers requirements.

Hydraulic Tip: 1 Tonne capacity hydraulic tip 50" high.

3 Way Hydraulic Tip: Single on 3 way Hydraulic Tip.

Due to Company Policy of continual improvement we reserve the right to change the design or specification at any time without notice. For exact information about any modification contact manufacturer or dealer.

Your Powerfab Distributor.

POWERFAB
SALES & SPARES LIMITED
FAIR VIEW, ASHVALE,
TREDEGAR, GWENT NP2 3HA
UNITED KINGDOM.
TELEPHONE: 049525 - 6627.
TELEX: 498973 POWFAB G.
FAX: 0495 - 718162

POWERFAB MULTI TRAK

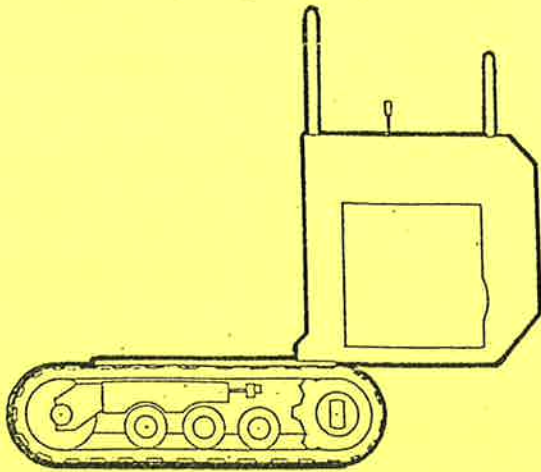
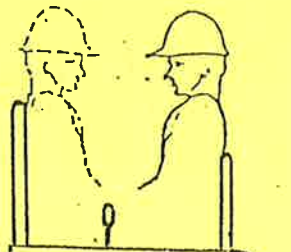

MULTI TRAK TOOL CARRIER
price £ 6,000

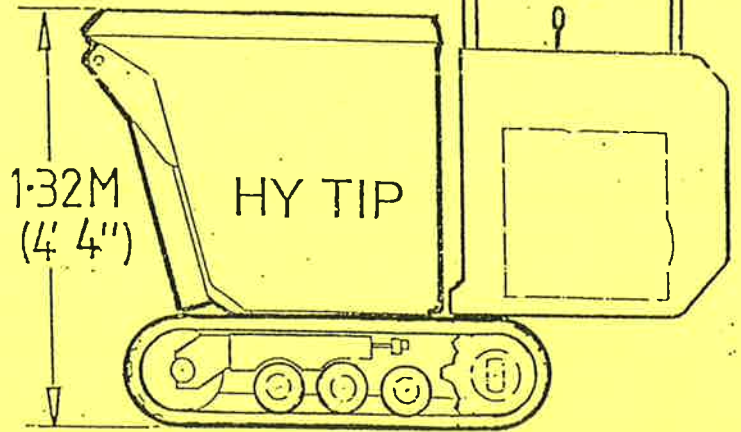

HY TIP DUMPER
price £ 6,900

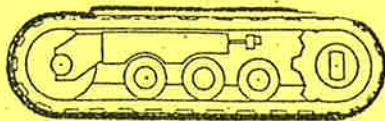

UNDERCARRIAGE
Price £ 3500

30" TO 40" VARIABLE
0.762m - 1.016m



8" (200) WIDE
TRACK

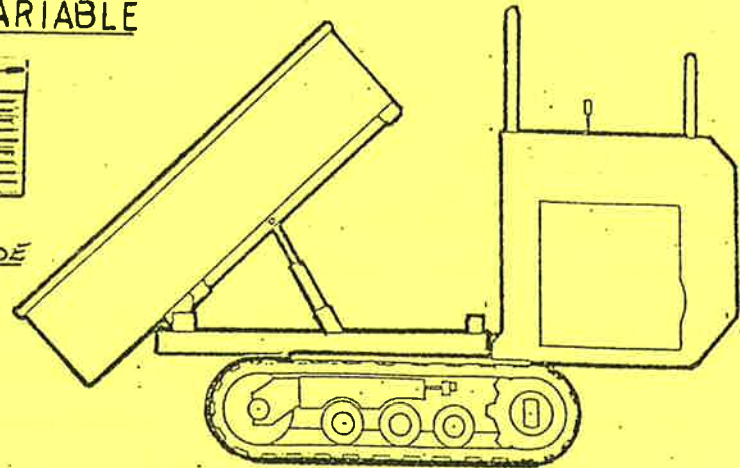

ONE WAY OR THREE WAY TIP
price one way tip £ 6900
price three way tip £ 7250

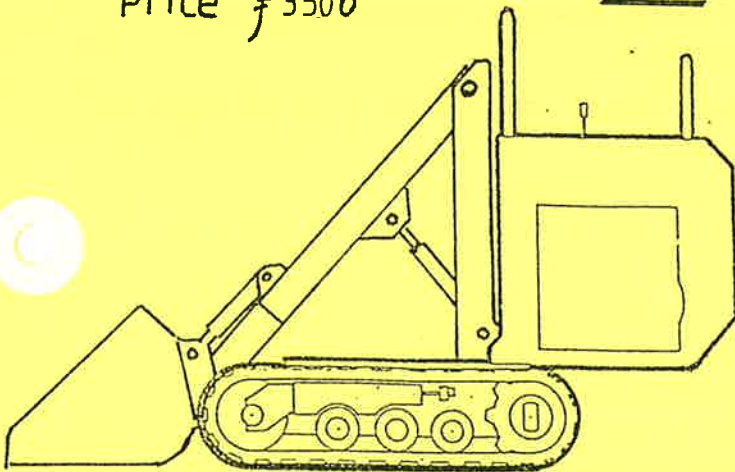

TRACK LOADER
price £ 8,100

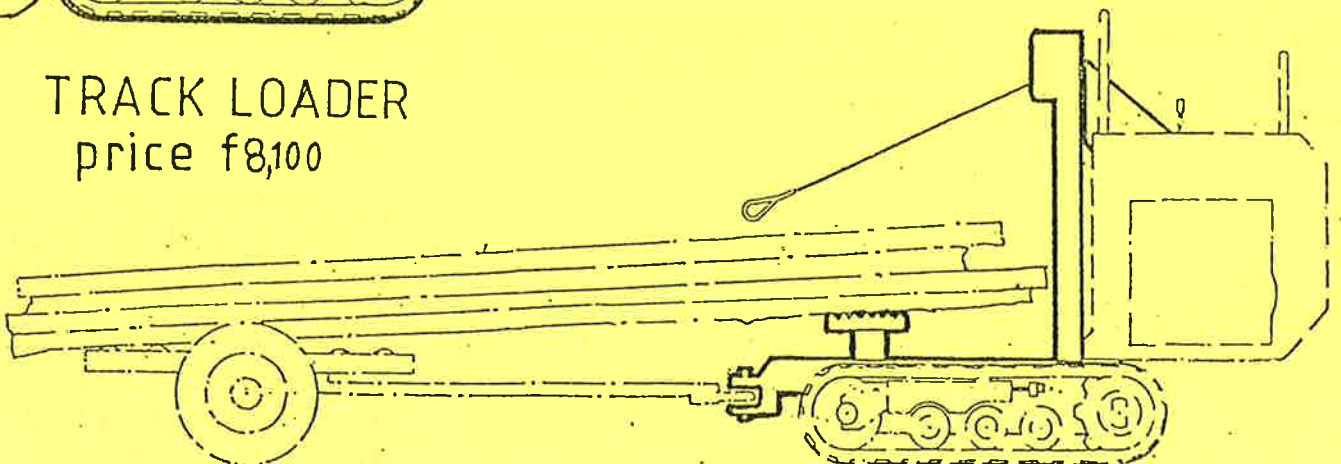

LOG HANDLING CARRIER AND HYDRAULIC WINCH
PRICE TO BE ADVISED

POWERFAB MULTI TRAK

THE POWERFAB MULTI-TRAK TOOL CARRIER CAN BE SUPPLIED AS A BASIC MACHINE (AS ILLUSTRATED OVERLEAF) ON WHICH CUSTOMERS CAN MOUNT POWERFAB OR THEIR OWN SPECIALIZED EQUIPMENT. IT CAN ALSO BE SUPPLIED WITH ANY ONE OF THE EXTENSIVE RANGE OF POWERFAB FACTORY MOUNTED TOOLS.

APART FROM THE TOOLS SHOWN OVERLEAF, ATTACHMENTS ARE AVAILABLE FOR A WIDE RANGE INCLUDING HYDRAULIC BREAKERS, TRENCHERS POLE HOLE BORERS, DOZER BLADES AND BRUSHES ETC.

THE MACHINE IS ALSO FITTED WITH HYDRAULIC QUICK RELEASE COUPLINGS. THEY ARE FOR USE WITH HAND HELD ANCILLARY EQUIPMENT WHICH INCLUDES HAND HELD BREAKERS, CIRCULAR AND CHAIN SAWS, DRILLS, WATER PUMPS AND PRUNERS ETC.

FOR FURTHER INFORMATION CONTACT THE SALES DEPARTMENT AS SHOWN BELOW:

TECHNICAL INFORMATION

RATED CAPACITY 650 KILOS TO 1 TONNE.

MAX. SPEED: 3.13 (MPH). 5 (KPH).

ENGINE (STANDARD): BRIGGS & STRATTON 15HP TWIN CYLINDER AIR-COOLED OVERHEAD VALVE PETROL ENGINE (BRIGGS & STRATTON VANGUARD).

ENGINE (OPTIONAL): PERKINS 3 CYLINDER WATER COOLED ENGINE. ELECTRIC START. 21.2HP @ 3600 RPM. ENGINE WORKING SPEED 2700 RPM.

HYDRAULIC SYSTEM: TURBO COOLED HYDRAULIC SYSTEM TANDEM HYDRAULIC PUMP.

HYDRAULIC POWER TAKE OFF: 26 LPM AT 186 BAR COMPLETE WITH QUICK RELEASE COUPLINGS FOR HAND HELD BREAKER WATER PUMP ETC.

UNDER CARRIAGE: TRACK - REINFORCED RUBBER.
NO. OF ROLLERS - 3 PER TRACK. - WIDTH = 42"

OPERATION (DRIVE): STEERING AND FORWARD AND REVERSE DRIVE CONTROLLED BY TWO LEVERS.
INDEPENDENT HYDROSTATIC DRIVE TO TRACKS. 3 SPEED.

HYDRAULIC CARRIER: SUPPLIED FOR FITTING SPECIALBODIES AND ATTACHMENTS TO CUSTOMERS REQUIREMENTS.

HY-TIP: 1 TONNE CAPACITY HYDRAULIC TIP 52" HIGH.

HYDRAULIC TIPPER: SINGLE OR 3 WAY HYDRAULIC TIP.

Due to our policy of continual improvement, we reserve the right to amend design or specifications without prior notice.

For further information contact our Sales Dept. at the address given below.

Your Powerfab Distributor.

POWERFAB
SALES & SPARES LIMITED

FAIR VIEW, ASHVALE,
TREDEGAR, GWENT NP2 3HA
UNITED KINGDOM.
TELEPHONE: 049525 - 6627.
TELEX: 498973 POWFAB G.
FAX: 0495 - 718162

POWERFAB MULTI TRAK

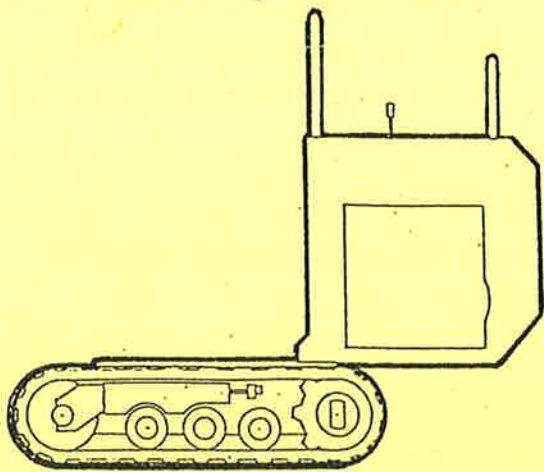
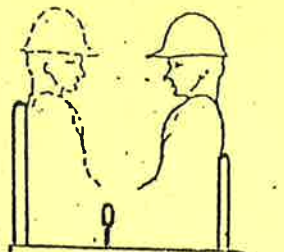

MULTI TRAK TOOL CARRIER
price £6600.00

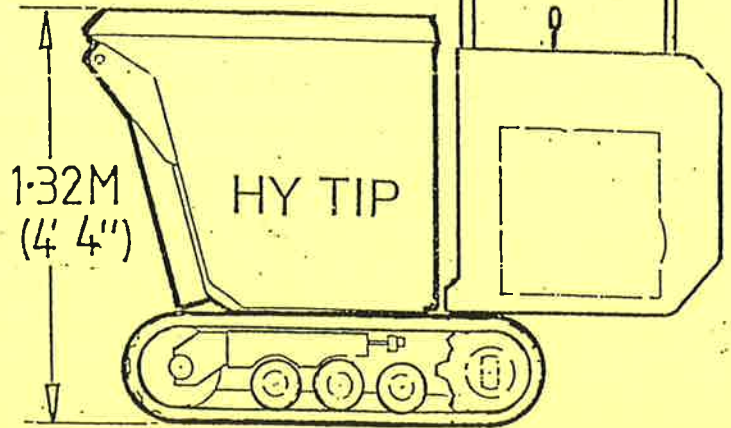

HY TIP DUMPER
price £7600.00

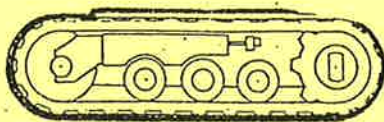

UNDERCARRIAGE
Price £3850.00

30" TO 40" VARIABLE
0.762m - 1.016m

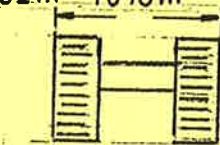

8" (200) WIDE
TRACK

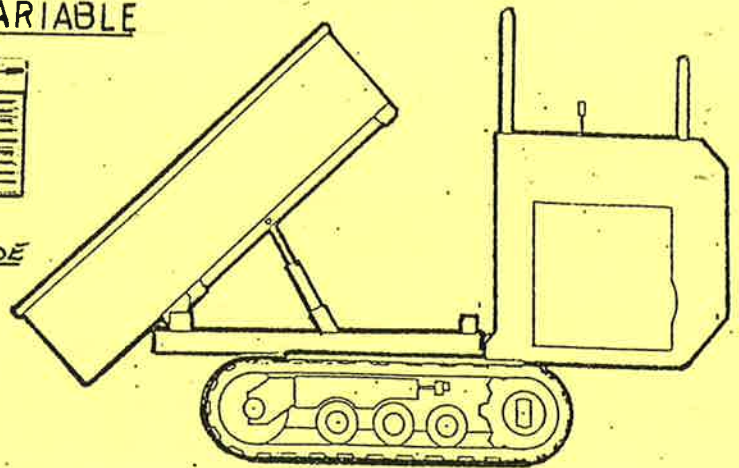

ONE WAY OR THREE WAY TIP
price one way tip £7600.00
price three way tip £7975.00

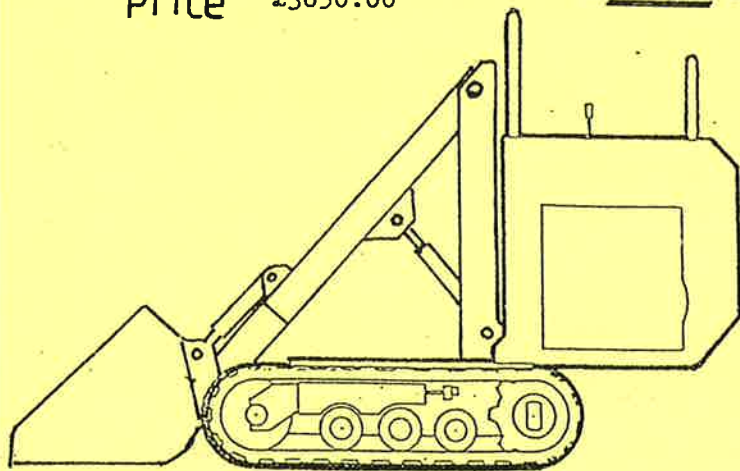

TRACK LOADER
price £8900.00

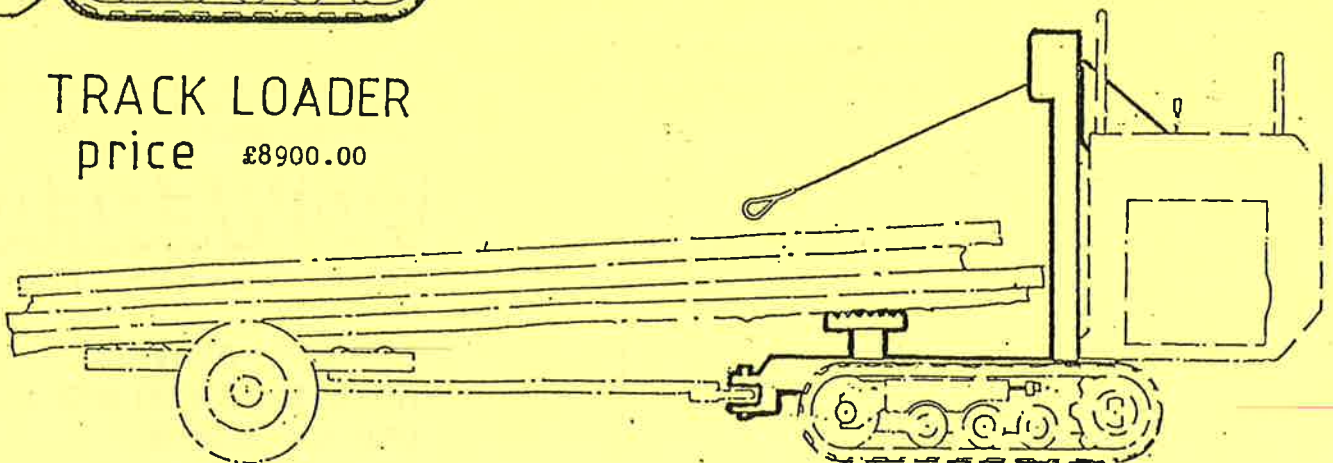

LOG HANDLING CARRIER AND HYDRAULIC WINCH
PRICE TO BE ADVISED

POWERFAB

MULTI TRAK

THE POWERFAB MULTI-TRAK TOOL CARRIER CAN BE SUPPLIED AS A BASIC MACHINE (AS ILLUSTRATED OVERLEAF) ON WHICH CUSTOMERS CAN MOUNT POWERFAB OR THEIR OWN SPECIALIZED EQUIPMENT. IT CAN ALSO BE SUPPLIED WITH ANY ONE OF THE EXTENSIVE RANGE OF POWERFAB FACTORY MOUNTED TOOLS.

APART FROM THE TOOLS SHOWN OVERLEAF, ATTACHMENTS ARE AVAILABLE FOR A WIDE RANGE INCLUDING HYDRAULIC BREAKERS, TRENCHERS POLE HOLE BORERS, DOZER BLADES AND BRUSHES ETC.

THE MACHINE IS ALSO FITTED WITH HYDRAULIC QUICK RELEASE COUPLINGS. THEY ARE FOR USE WITH HAND HELD ANCILLARY EQUIPMENT WHICH INCLUDES HAND HELD BREAKERS, CIRCULAR AND CHAIN SAWS, DRILLS, WATER PUMPS AND PRUNERS ETC.

FOR FURTHER INFORMATION CONTACT THE SALES DEPARTMENT AS SHOWN BELOW:

TECHNICAL INFORMATION

RATED CAPACITY 650 KILOS TO 1 TONNE.

MAX. SPEED: 3.13 (MPH). 5 (KPH).

ENGINE (STANDARD):	BRIGGS & STRATTON 15HP TWIN CYLINDER AIR-COOLED OVERHEAD VALVE PETROL ENGINE (BRIGGS & STRATTON VANGUARD).
ENGINE (OPTIONAL):	PERKINS 3 CYLINDER WATER COOLED ENGINE. ELECTRIC START. 21.2HP @ 3600 RPM. ENGINE WORKING SPEED 2700 RPM.
HYDRAULIC SYSTEM:	TURBO COOLED HYDRAULIC SYSTEM TANDEM HYDRAULIC PUMP.
HYDRAULIC POWER TAKE OFF:	26 LPM AT 186 BAR COMPLETE WITH QUICK RELEASE COUPLINGS FOR HAND HELD BREAKER WATER PUMP ETC.
UNDER CARRIAGE:	TRACK - REINFORCED RUBBER. NO. OF ROLLERS - 3 PER TRACK. - WIDTH = 42"
OPERATION (DRIVE):	STEERING AND FORWARD AND REVERSE DRIVE CONTROLLED BY TWO LEVERS. INDEPENDENT HYDROSTATIC DRIVE TO TRACKS. 3 SPEED.
HYDRAULIC CARRIER:	SUPPLIED FOR FITTING SPECIALBODIES AND ATTACHMENTS TO CUSTOMERS REQUIREMENTS.
HY-TIP:	1 TONNE CAPACITYHYDRAULIC TIP 52" HIGH.
HYDRAULIC TIPPER:	SINGLE OR 3 WAY HYDRAULIC TIP.

Due to our policy of continual improvement, we reserve the right to ammend design or specifications without prior notice.

For further information contact our Sales Dept. at the address given below.

Your Powerfab Distributor.

POWERFAB
SALES & SPARES LIMITED

FAIR VIEW, ASHVALE,
TREDEGAR, GWENT NP2 3HA
UNITED KINGDOM.
TELEPHONE: 049525 - 6627.
TELEX: 498973 POWFAB G.
FAX: 0495 - 718162